

 **NEOTRA**[®]
STONEVENTIONS

A CLASSIC STYLE OF THE
KITCHEN PLATFORM COLLECTION.



INVENTING UNIQUE STONES

We have witnessed various kinds of stones used to our advantage for different purposes. However, the physical characteristics of natural stones, marbles, and artificial stones such as quartz and engineered stones, make them vulnerable to scratches, stains, heat, and external weather. To overcome these limitations and replace them, we at Simpolo have made stone inventions under the brand Neotra.

Neotra-Stoneventions offers stones having 12mm and 20mm thickness with a homogeneous structure as well as colour body with contemporary designs. They are far more superior than any natural or artificial stones. Neotra stones are stain-free, anti-bacterial, scratch-resistant, and have more strength. We have created unique Neotra stones using natural minerals for a better tomorrow.

Encompass the urban
allure in your spaces



SPA Collection

Establish an ageless
prominence in your spaces



SPA WHITE | 12



SPA SILVER | 14



SPA BLACK | 16



SPA MOCHA | 18



SPA BARLEY | 20



SPA BIANCO | 22

INMENSA Collection

Instill the fascinating
elegance and charm



CARRARA TWING | 30



MICHELANGELO RUST | 32



SARONA NIGHT | 34



STATUARIO NATURAL | 36



AGARSEN NERO | 38



STATUARIO ELEGANT | 40



NEOTRA stones offer designs that flaunt unique features, an individualistic streak, superior quality, and advanced technology within a state of the art infrastructure facility which produces the best products with a distinct edge. These slabs are all temperature resistant, require low maintenance effort as these are liquid repellent, scratch-resistant and are easy to mould. Install and elevate the look of your kitchen spaces with NEOTRA stones.

FEATURES

The most important requirement in these modern times is the urgent need for hygiene. These Neotra stones are easy to clean providing you a germ-free surface.

iM+
iM+ Technology.
Towards A Better You

POSHTM
SURFACE
Confidently Smooth,
Comfortably Elegant.



Antibacterial surface

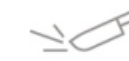

Scratch and Abrasion resistant



Liquid repellent



Fire resistant

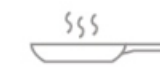

Heat resistant



Chemical and Stain resistant



Frost resistant



Impact resistant



Resistant to bending



Lowest maintenance efforts



iM⁺

**iM⁺ Technology,
Towards A Better You**



Antibacterial surface



Liquid repellent

We have never been as precautious as we are now about our health and hygiene. We are battling every day to increase our immunity and keep ourselves fit.

'iM+ Technology' is our most exciting innovation yet. It helps the product surface repel any liquid. It does not allow unwanted and harmful living organisms to stay and/or grow. It requires the lowest maintenance efforts.

We have and we always will put in our efforts to keep your place better and safer.



POSHTM SURFACE

Confidently Smooth,
Comfortably Elegant.



Lowest maintenance efforts



Scratch and Abrasion resistant

As smooth as the breezing wind, 'POSH Surface' is yet another achievement for us. The exceptional surface is achieved with the exclusive and patented Italian technology, which is the first of its kind in India. It takes the surface quality to where no other technology can reach.

With this innovation, we have overcome the myth that smooth surfaces get scratches and stains. Despite having the unmatched smoothness, 'POSH Surface' is resistant to scratches.



12mm

12mm - GLORIOUS TOPS
WITH REGAL STYLE
Get magnificent kitchens
with neotra stones

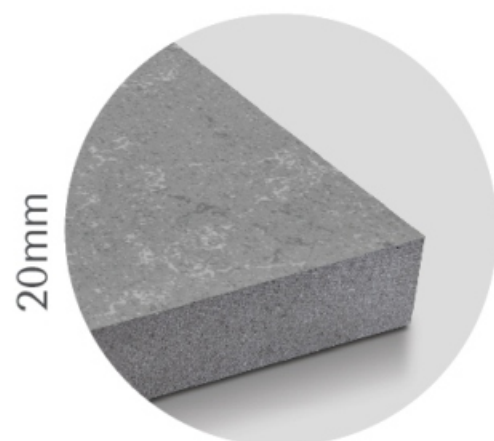

20mm

20mm - ENVISION THIS
BEAUTY IN YOUR DECOR
Transform your kitchen into
something beautiful forever

12mm | 20mm
EVOLVE YOUR
KITCHEN TOPS

EDGE PROFILES

Giving nice trim to edges of the tiles that adds to its beauty. As these tiles are of the good thickness of 12mm and 20mm, it is possible to shape its edges in diferent styles and create aesthetically rich countertops for your space. Well trimmed edges also make for cleaner and elegant joints.



Double Bevel



Big Bevel



NEOTRA[®]
STONEVENTIONS

SPA
Collection

12mm & 20mm

A flawless blend of elegance and durability.
Maintains all the parameters of surfaces strength, water
absorption and heat resistance.

SPA
Collection



SPA WHITE



Size / Thickness

145x320cm - 57"x126"
160x320cm - 63"x126"
Surface - Posh

- ✚ 20mm Rectified
- ✚ 12mm Rectified



Scan for Virtual
360°



SPA SILVER



Scan for Virtual
360°



Size / Thickness

145x320cm - 57"x126"
160x320cm - 63"x126"
Surface - Posh

- ✦ 20mm Rectified
- ✦ 12mm Rectified

SPA BLACK



Size / Thickness

145x320cm - 57"x126"
160x320cm - 63"x126"
Surface - Posh

- ✦ 20 mm Rectified
- ✦ 12 mm Rectified



Scan for Virtual
360°

SPA MOCHA



Scan for Virtual
360°



Size / Thickness

145x320cm - 57"x126"
160x320cm - 63"x126"
Surface - Posh

- ✦ 20 mm Rectified
- ✦ 12 mm Rectified

SPA BARLEY



Size / Thickness

145x320cm - 57"x126"

160x320cm - 63"x126"

Surface - Posh

✚ 20 mm Rectified

✚ 12 mm Rectified



Scan for Virtual
360°



SPA BIANCO



Scan for Virtual
360°



Size / Thickness

145x320cm - 57"x126"
160x320cm - 63"x126"
Surface - Posh

- ✦ 20 mm Rectified
- ✦ 12 mm Rectified

SPA Collection

Create a grand and fabulous kitchen space with SPA Collection as these stones give your decor a dynamic and compelling style.

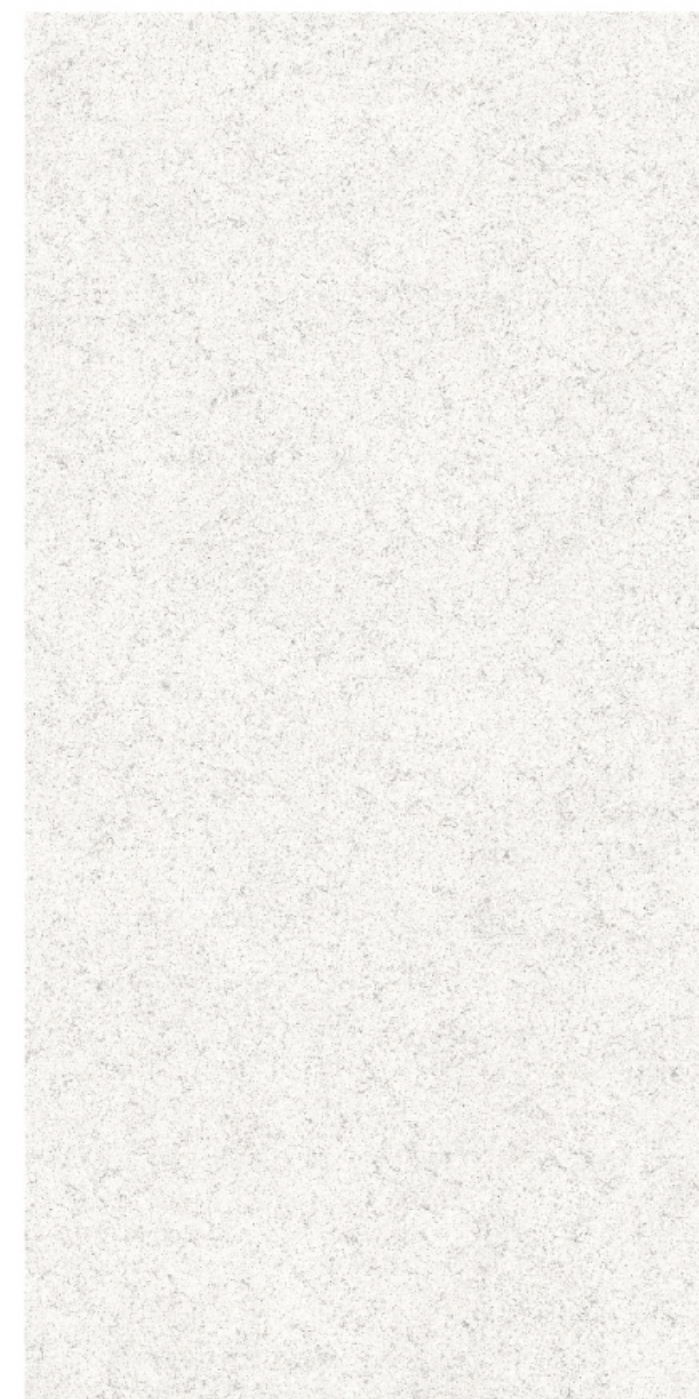

SPA WHITE



145x320cm - 57"x126" Posh

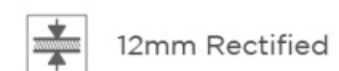

160x320cm - 63"x126" Posh



SPA SILVER



145x320cm - 57"x126" Posh

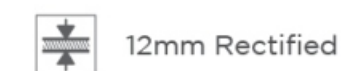

160x320cm - 63"x126" Posh



SPA BLACK

 20mm Rectified

145x320cm - 57"x126" Posh

 12mm Rectified

160x320cm - 63"x126" Posh



SPA MOCHA

 20mm Rectified

145x320cm - 57"x126" Posh

 12mm Rectified

160x320cm - 63"x126" Posh



SPA BARLEY

 20mm Rectified

145x320cm - 57"x126" Posh

 12mm Rectified

160x320cm - 63"x126" Posh



SPA BIANCO

 20mm Rectified

145x320cm - 57"x126" Posh

 12mm Rectified

160x320cm - 63"x126" Posh



NEOTRÀ[®]
STONEVENTIONS

INMENSA

Collection

12mm & 20mm

An immensely timeless collection of stones offering a refined marble experience in your spaces.

INMENSA Collection

CARRARA TWING



Size / Thickness

145x320cm - 57"x126"
160x320cm - 63"x126"
Surface - Posh

- ✦ 20mm Rectified
- ✦ 12mm Rectified



Scan for Virtual
360°





MICHELANGELO RUST



Scan for Virtual
360°

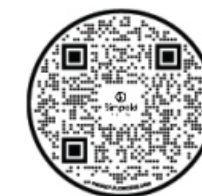

Size / Thickness

145x320cm - 57"x126"
160x320cm - 63"x126"
Surface - Posh

- ✦ 20mm Rectified
- ✦ 12mm Rectified

SARONA NIGHT



Size / Thickness

145x320cm - 57"x126"
160x320cm - 63"x126"
Surface - Posh

- ✦ 20mm Rectified
- ✦ 12mm Rectified



Scan for Virtual
360°





STATUARIO NATURAL



Scan for Virtual
360°



Size / Thickness

145x320cm - 57"x126"
160x320cm - 63"x126"
Surface - Posh

- ✦ 20mm Rectified
- ✦ 12mm Rectified

AGARSEN NERO



Size / Thickness

145x320cm - 57"x126"
160x320cm - 63"x126"
Surface - Posh

- ✚ 20mm Rectified
- ✚ 12mm Rectified



Scan for Virtual
360°





STATUARIO ELEGANT



Scan for Virtual
360°



Size / Thickness

145x320cm - 57"x126"
160x320cm - 63"x126"
Surface - Posh

- ✦ 20mm Rectified
- ✦ 12mm Rectified

INMENSA Collection

Bring the charismatic charm to
your Kitchen and dining spaces
with the exquisite marble designs of
INMENSA collection



CARRARA TWING



20mm Rectified

145x320cm - 57"x126" Posh



12mm Rectified

160x320cm - 63"x126" Posh



MICHELANGELO RUST

 20mm Rectified

145x320cm - 57"x126" Posh

 12mm Rectified

160x320cm - 63"x126" Posh



SARONA NIGHT

 20mm Rectified

145x320cm - 57"x126" Posh

 12mm Rectified

160x320cm - 63"x126" Posh



STATUARIO NATURAL



20mm Rectified

145x320cm - 57"x126" Posh



12mm Rectified

160x320cm - 63"x126" Posh



AGARSEN NERO



20mm Rectified

145x320cm - 57"x126" Posh



12mm Rectified

160x320cm - 63"x126" Posh



STATUARIO ELEGANT



20mm Rectified

145x320cm - 57"x126" Posh



12mm Rectified

160x320cm - 63"x126" Posh

TECHNICAL SPECIFICATION

CHARACTERISTIC	STANDARD AS PER ISO13006:2018 / EN14411 Gr. Bla	METHOD OF TESTING	POSH	POLISHED (UG)	POLISHED (GL)
Regulatory Properties					
Deviation in Length and Width*	±0.30 % (±100 mm)	ISO 10545-2	±10 mm (±0.20 %)	±10 mm (±0.20 %)	±10 mm (±0.20 %)
Deviation in Thickness*	±5.0 % (±50 mm)	ISO 10545-2	±0.5 mm (±5.0 %)	±0.5 mm (±5.0 %)	±0.5 mm (±5.0 %)
Straightness in Side*	±0.30 % (±0.80 mm)	ISO 10545-2	±0.8 mm(±0.20 %)	±0.8 mm(±0.20 %)	±0.8 mm(±0.20 %)
Rectangularity*	±0.30 % (±150 mm)	ISO 10545-2	±12 mm(±0.20 %)	±12 mm(±0.20 %)	±12 mm(±0.20 %)
Surface Flatness Central Curvature*	±0.40 % (±180 mm)	ISO 10545-2	±18 mm(±0.20 %)	±18 mm(±0.20 %)	±18 mm(±0.20 %)
Surface Flatness Edge Curvature*	±0.40 % (±180 mm)	ISO 10545-2	±18 mm(±0.20 %)	±18 mm(±0.20 %)	±18 mm(±0.20 %)
Surface Flatness Warpage*	±0.40 % (±180 mm)	ISO 10545-2	±18 mm(±0.20 %)	±18 mm(±0.20 %)	±18 mm(±0.20 %)
Surface Quality	>95% defects free	ISO 10545-2	>95% defects free	>95% defects free	>95% defects free
Small Color Difference (For Plain Colour)	ΔE <1.00	ISO 10545-16	ΔE <0.80	ΔE <0.80	ΔE <0.80
Structural Properties					
Water Absorption	≤0.50 %	ISO 10545-3	≤0.080 %	≤0.080 %	≤0.080 %
Bulk Density	As per Manufacturer	ISO 10545-3	> 2.28 gm/cc	> 2.28 gm/cc	> 2.28 gm/cc
Massive Mechanical Properties					
Modulus of Rupture >7.5 mm	Min. 35.0 N/mm ²	ISO 10545-4	Min. 45.0 N/mm ²	Min. 45.0 N/mm ²	Min. 45.0 N/mm ²
Breaking Strength Thickness >7.5 mm (12 mm)	Min 13000.0 N	ISO 10545-4	Min 25000.0 N	Min 25000.0 N	Min 25000.0 N
Breaking Strength Thickness >7.5 mm (20 mm)	Min 13000.0 N	ISO 10545-4	Min 75000.0 N	Min 75000.0 N	Min 75000.0 N
Surface Mechanical Properties					
MOHS Hardness	As per Manufacturer	BS EN 15771	Min 6	Min 4	Min 4
Surface Abrasion Resistance	As per Manufacturer	ISO 10545-7	PEI III	-	PEI II
Deep Abrasion	≤175 mm	ISO 10545-6	≤132 mm	≤132 mm	-
Thermal Hygrometric Properties					
Moisture Expansion	Max 0.06% (0.6 mm/m)	ISO 10545-10	Max 0.02 mm/m	Max 0.02 mm/m	Max 0.02 mm/m
Thermal Expansion(COE) at 100°C	As per Manufacturer	ISO 10545-8	Max. 6.0 x 10 ⁻⁶	Max. 6.0 x 10 ⁻⁶	Max. 6.0 x 10 ⁻⁶
Thermal Shock Resistance	Min 10 Cycle	ISO 10545-9	Min 10 Cycle	Min 10 Cycle	Min 10 Cycle
Impact Resistance(COR) #	Min. 0.55	ISO 10545-5	Min 0.55	Min 0.55	Min 0.55
Frost Resistance	As per Manufacturer	ISO 10545-12	Frost Proof	Frost Proof	Frost Proof
Crazing Resistance at 7.5 bar	4 Cycle	ISO 10545-11	-	-	4 Cycle
Chemical Properties					
Resistance to Staining	Min. Class 3	ISO 10545-14	Min. Class 4	Min. Class 4	Min. Class 4
Resistance to Household Chemicals & Swimming Pool	Min Class GB	ISO 10545-13	Min Class UB	Min Class UB	Min Class GB
Resistance to Low Concentrate Acid and Alkalis	As per Manufacturer	ISO-10545-13	Min Class ULB***	Min Class ULB***	Min Class GLB***
Resistance to High Concentrate Acid and Alkalis	As per Manufacturer	ISO-10545-13	Min Class UHB***	Min Class UHB***	Min Class GHB***
Safety Properties Skid Resistance - (DCOF-WET PENDULUM)	As per Manufacturer	BS 7976-2	P1	-	-
Slip Resistance - (DCOF- R Value)	As per Manufacturer	DIN 51130	R9	-	-
Lead and Cadmium release (lead Concentration)	As per Manufacturer	ISO-10545-15	<0.01 mg/dm ³	Does not yield	<0.01 mg/dm ³
Lead and Cadmium release (Cadmium Concentration)	As per Manufacturer	ISO-10545-15	<0.001 mg/dm ³	Does not yield	<0.001 mg/dm ³

* Whichever is less is applicable for Rectified Size N>=15 CM

*** Except Hydrofluoric Acid & it's compound

Note: Length and width, orthogonality and straightness are not applicable for the NOT-rectified material.

PACKING DETAILS

PRODUCT	SIZE	ACTULE SIZE	THICKNESS	TILES / BOX	COVERAGE AREA / BOX
NEOTRA	145 x 320cm	1450 x 3200mm	20mm	1	4.64 Sqm
	160 x 320cm	1600 x 3200mm	12mm	1	5.12 Sqm

TRANSPORTING A NEOTRA STONE

When removing the Neotra stones from the A-frame (Fig-A), it is necessary to do it from alternate sides for greater safety. Removing one stone from one side and the next one from the other side keeps the load symmetrical and more stable.

To move single Neotra stone and position it on a rack or a machine that will process it to the finished stone, it is possible to use suction pad lifting equipment with several grab points supported by an overhead travelling crane (Fig-B) or a jib crane, depending on the weight of the individual stone.

The single Neotra stone can be moved with cloth straps (Fig-C) or slings coated in rubber with overhead crane or with forklift truck (Fig-D). Never use chains or steel cable because these materials can damage the surface and edges. In fact, chains and steel would scratch the surfaces of stone and could leave steel residue on natural materials which would then require careful cleaning.

If handling with grippers, insert rubber grip covers to protect Neotra stone.

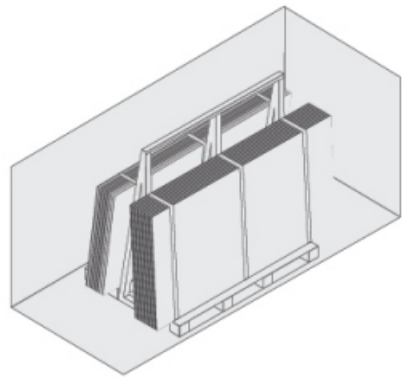

Fig-A

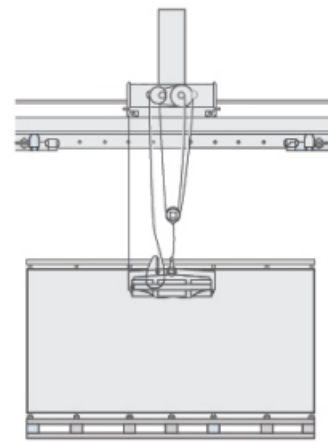

Fig-B

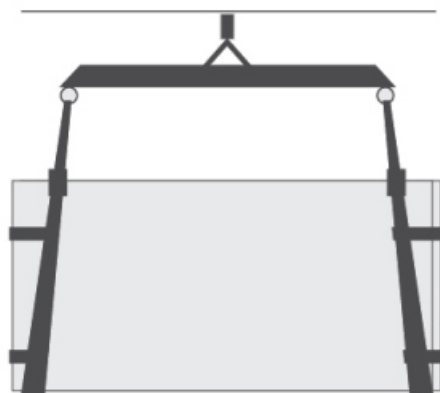

Fig-C

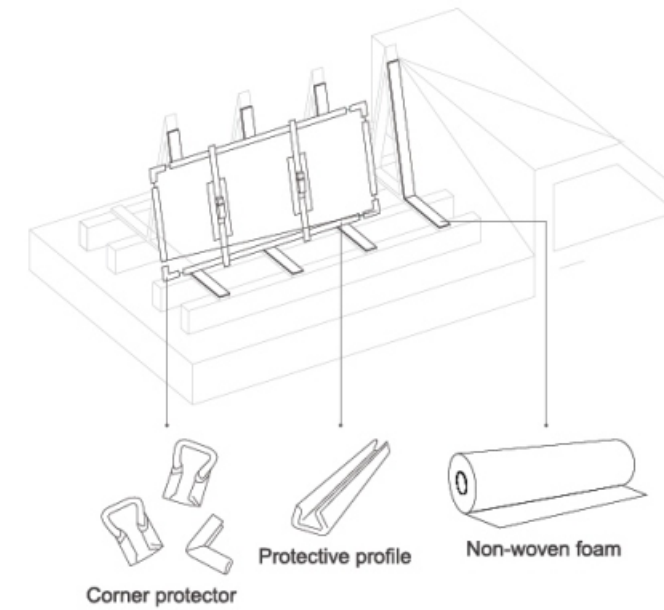

Fig-D

TRANSPORT BY LORRY

Place the material, with all edges and corners protected, vertically on trestles, securing them with canvas slings and protecting the ratchets.

Special care must be taken with pieces with holes made in the workshop.



MOVEMENT WITH MANUAL SUCTION CUPS-

To facilitate handling the stone, it is recommended to carry and install them with runners and frames with suction cups to keep them more rigid and limit any twisting or bending. There are two types of suction cups available, the traditional type and those with an in-built pump. The latter type is more secure and provides a better grip and the vacuum in the suction cup can be re-established using the pump, even after a certain period of time. Always make sure a good vacuum has been created between the lifting device and the surface of the stone.

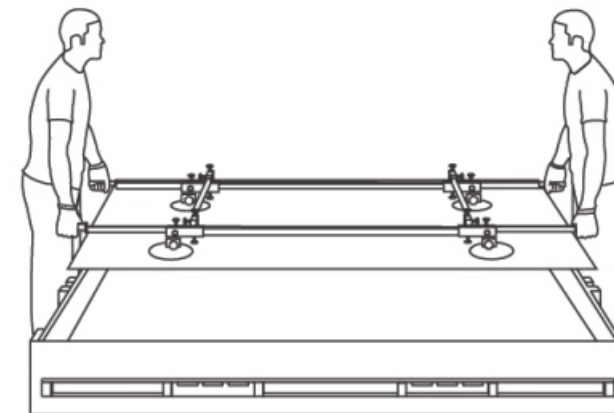

WORKING WITH THE VARIOUS VERSIONS OF NEOTRA STONE

CUTTING WITH DIAMOND DISCS



- All products of Neotra can be cut using diamond discs fitted onto the hand-held electrical grinding machine. In this case, the STONE will have a cleaner and better defined edge than by cutting and breaking the STONE

Before starting, check the following:

- The cutting table should be solid and robust.
- It must be perfectly flat and level (the quality is improved using a Rubber surface, to buffer the blade vibrations).
- Check that the surface that the NEOTRA STONE is placed on is in good condition (the piece is perfectly supported and there are no surface irregularities that affects the adhesion of the NEOTRA STONE).
- Only use standardized blades to cut NEOTRA STONE. Generally, these tools work at slow speeds and are highly cooled.
- The blade must be in good condition (the tool should be within its product life cycle and there should be no surface damage).
- The cooling process for this type of work is very important. The coolant flow must point directly at the cutting point and not indirectly. Use the maximum flow allowed by the machinery.
- If it is a special machine where the cutting process can be carried out immersed in water, this process should always be used to optimize the cooling process, to improve the surface quality and extend the life of the tool.

THE RECOMMENDED CUTTING SPEEDS OF BLADES FOR NEOTRA STONE ARE AS FOLLOWS:

§For 12 mm NEOTRA STONES: 1 m/min – 1.5 m/min*
§For 20 mm NEOTRA STONES: 0.5 m/min – 1 m/min*

*Depending on the type of blade to be used and the brand, it is necessary to adjust the specific revolutions and speeds. To do so, use a suitable blade depending on the type of machinery available. If the machine has a frequency converter, any blade out of those recommended can be used, by simply adjusting the revolutions.

REQUIREMENTS OF MACHINE

§Cooling water flow focused on the cutting area
§Use large flange
§Support of larger dimension of the NEOTRA STONE
§Sharpen frequently the diamond
§Well-levelled bed support
§Blade depth 1/8 inch to 3/16 inch on the cutting bed

-If the edges of the STONE are sharp or uneven after it has been broken, clean and smooth the edges with a diamond pad or an abrasive discs

DRILLING

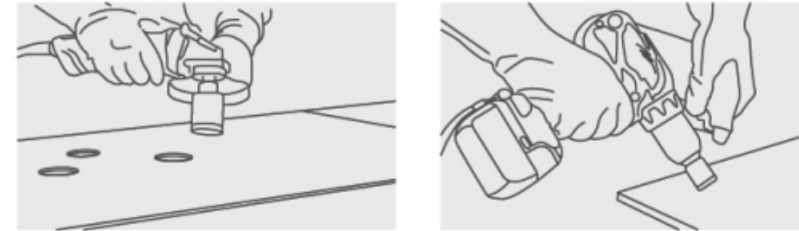

- As an alternative, you can use cutting discs fitted to angle grinders, electrical drills or battery-operated screwdrivers.

Only use standardized blades to machine NEOTRA STONE. In general, the tools operate at very slow speeds and are highly cooled (ideally immersed). For which, it is recommended to place a container on the NEOTRA STONE surface, containing the coolant while drilling.

In the event of problems securing the drill at the start of the work, use holes in a material as a guide, to then attach to NEOTRA STONE with the use of clamps. Another option is to slightly punch the surface of NEOTRA STONE and then use a small milling cutter to drill 5 mm. Then, the recommended drills can be used with a guide. If the drill is used directly on the material, the material must be fed at 45° until a 3 mm notch has been made. Then, the drill is gradually straightened until in a vertical position. Small circular movements should be made now to complete the work. It is vital to sharpen the tool after 4 drills with abrasive paste or similar.

INTERNAL CUT / L-SHAPED CUT

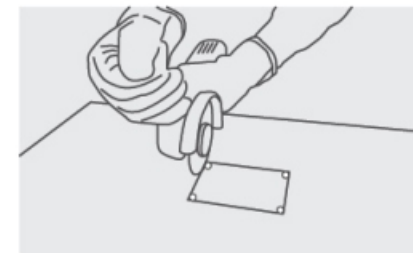

To make rectangular holes in stone, start by making a round hole at each corner of the rectangle. Then make straight cuts between each hole with a discs cutter with a diamond discs. This will prevent excessive stresses being generated at the corners of the rectangle which could then form a crack in the stone itself.

MINIMUM RADIUS AND DISTANCES

It is mandatory that any internal corner must be rounded.

Inside Corners on L-Shapes must have a minimum **10mm** radius

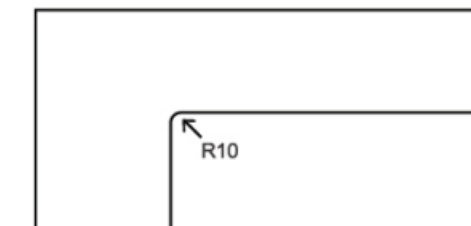

CUTOUTS

A minimum of 4mm radius is mandatory for inside corners except for L Shapes, where 10mm is required

Below are recommended examples of cut-outs for fittings such as sinks, hobs, columns, etc.

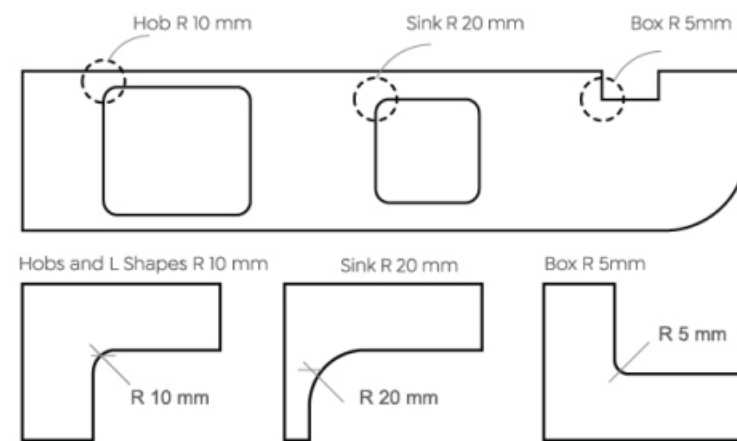

DRILLS AND SLITS

All incisions, slits or drills must pass through the material a maximum of half of the thickness.

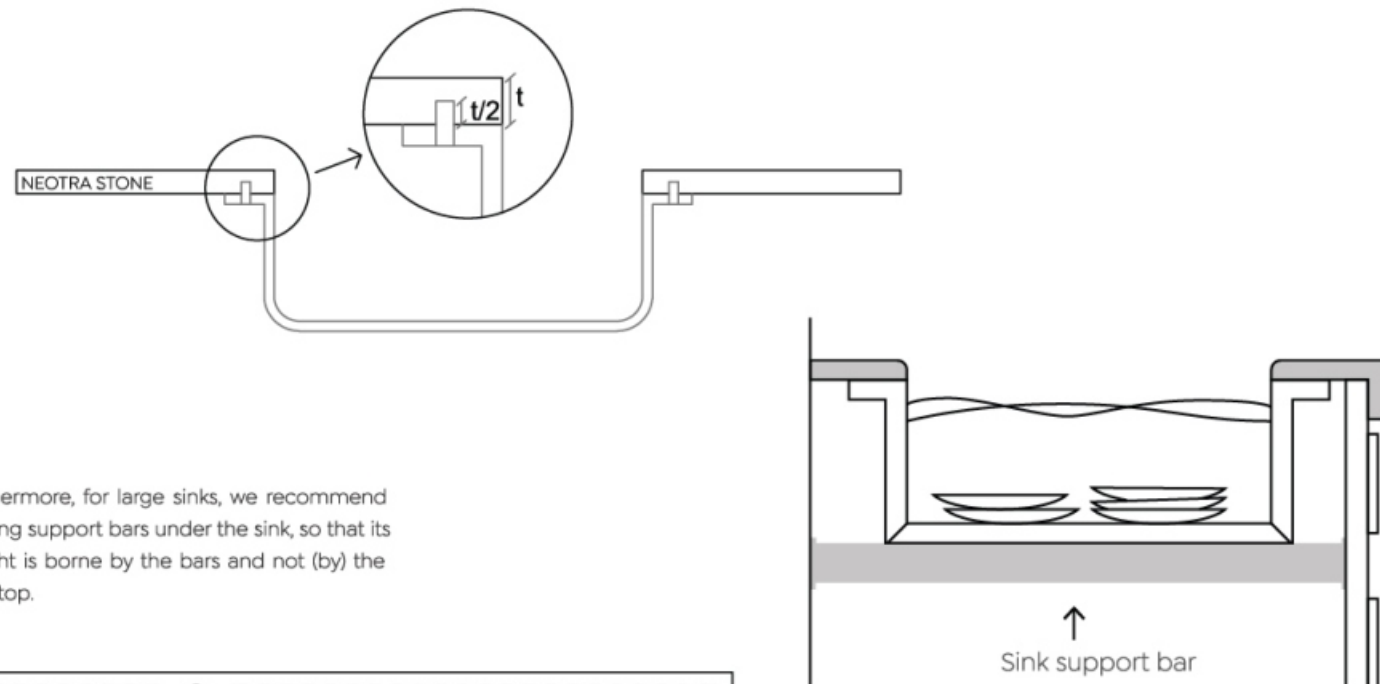

Furthermore, for large sinks, we recommend placing support bars under the sink, so that its weight is borne by the bars and not (by) the worktop.

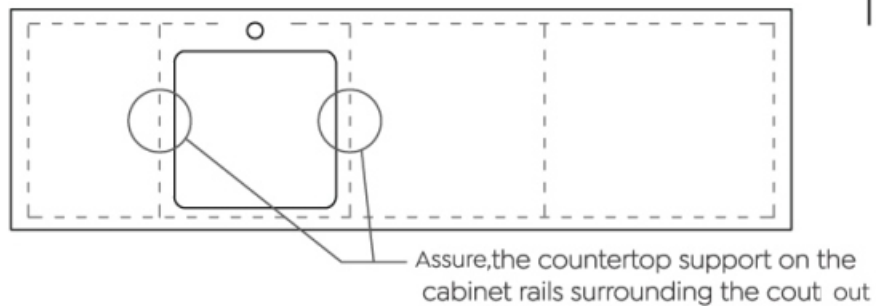

EDGE-FINISHING



Edges can be finished by using sanding discs fitted onto hand held angle grinder. The same result can be obtained by hand using abrasive diamond sponges or emery paper. With a light passage on the side of the slab, you can obtain a slightly rounded-off edge or with repeated passages a bevelled effect.

INSTRUCTION MANUAL FOR INSTALLATION:

DOUBLE-LAYER METHOD

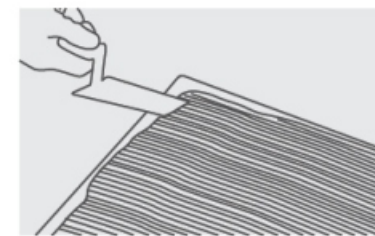

- The adhesive must be chosen according to the type of substrate material, the type and size of the STONE and the area of use. To spread the adhesive on the substrate use a spreader with sloping notches (with a pitch of at least 12 mm) to get better distribution of the adhesive. To spread the adhesive on the back of the STONE, on the other hand, use a spreader with smaller notches (square notches of at least 3-4 mm) so that almost 100% of the surface is wetted with adhesive.
- The adhesive should be applied in a straight line, with no circular movements, parallel to the short side of the STONE to reduce the distance travelled by the air being pushed out.
- The adhesive must be spread in the same direction on the back of the STONE and on the substrate (in straight lines parallel to the short side of the STONE). The same technique is used to install both floor and wall STONE. When installing STONE on facades, the design engineer must assess whether additional mechanical safety fasteners are required.
- Another essential requirement when installing large format STONE is that the adhesive must guarantee a high level of wetting of the back of the STONE so that gaps are not created, otherwise the soundness and durability of the bond could be affected.



To ensure the STONE is completely bonded and that all the air has come out, go over the surface of the STONE with a vibro-plate or tap the surface by hand with a special anti-bounce float made from rubber. We suggest tapping the STONE from the centre working towards the edges in the same direction as the ribs of adhesive, that is, parallel to the short side, to ensure all the air under the STONE is forced out.

GROUTING LARGE FORMAT STONES

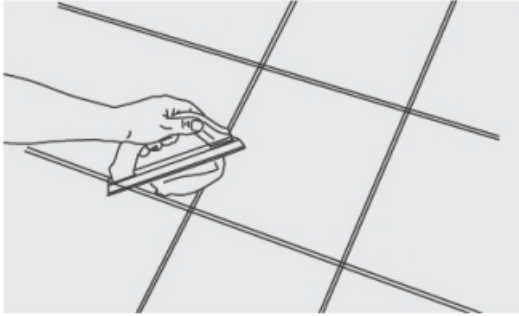

- The grout line between each STONE must be at least 2 mm wide and must be increased according to the size and type of the STONE, the area of use (floor or wall STONE, internal or external) and the stresses expected when in service.
- To maintain the correct gap between each STONE and reduce out-of-flatness between adjacent STONE, it is recommended to use spacers between the STONE (around one spacer every 50 cm).
- It is important to place the spacers in position before installing the STONE and that the spacers are embedded in the adhesive.
- To make this operation easier, a special positioning tool may be used to correct the width of the grout line between adjacent STONE and bring the STONE to the position required.
- The grout lines may be filled with an epoxy grout. Always clean out the grout lines with a cutter, an abrasive scraper, etc. before grouting.
- Clean the grout by using a small amount of water and an abrasive pad (such as Scotch Brite) followed by a firm cellulose sponge, taking care not to remove the grout.
- The cleaning of floor and wall STONE grouted with epoxy mortar must be carried out while the grout is still fresh, with a higher amount of water if necessary, in order to completely remove all epoxy resin residuals.

OTHER CONSIDERATIONS

- Joints with columns, mortises or other elements
- L-shaped pieces are not recommended.
- Therefore, in order to deal with joints with elements that "break" the continuity of the flooring, it is recommended to divide it into as many pieces as necessary.
- The aim is to avoid loose and flimsy 'arms' on the floor tiles, as this area of the material is very susceptible to breakage.

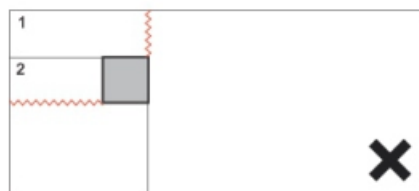

Joint with a column using L-shaped pieces

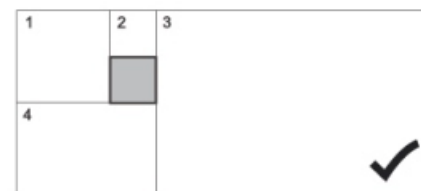

Joint with a column using straight pieces - OPTION A

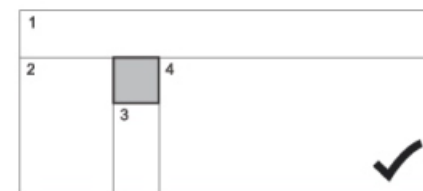

Joint with a column using straight pieces - OPTION B

CUTOUT DESIGN

The minimum distance between a cutout and the edge of the slab must be at least 2". The size recommends distances greater than 2" when the kitchen design allows as it makes the stone firmer.

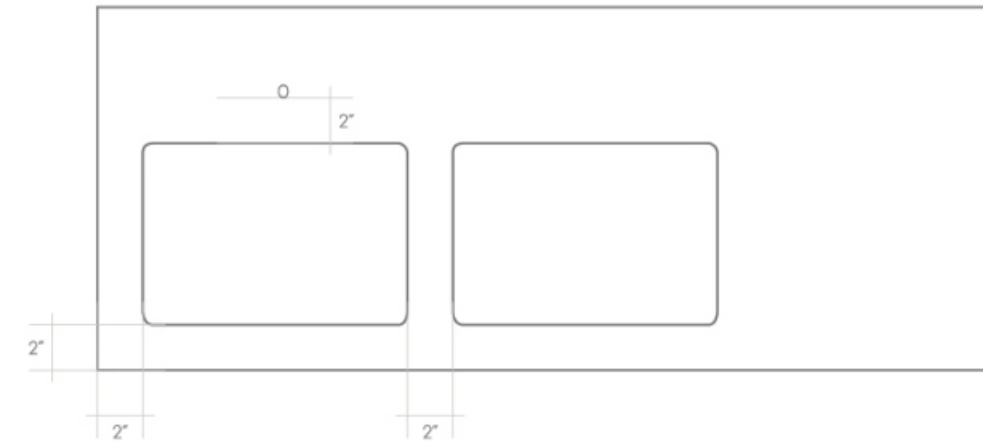

IMPORTANT



All cutout corners must have a minimum diameter of 1/4". Never leave 90° angles.

We recommend radiuses of more than 1/4" when the kitchen design allows as it makes the stone firmer.



✓ CORRECT



✗ INCORRECT



✗ INCORRECT



✗ INCORRECT

The correct way to create a cutout, except with waterjet and digital control bits, is to first drill the corners and then the rest of the cuts.

SOCKETS AND SWITCHES:

Gaps made to insert accessories (sockets, switches, etc.) should be done using circular drills; they may overlap.

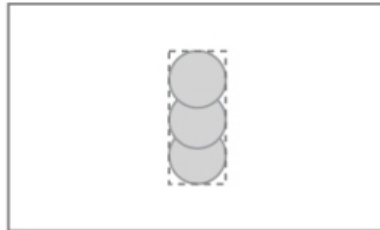

✓ CORRECT

CARE AND PRECAUTIONS

Routine maintenance - For daily cleaning, a damp microfiber cloth is enough. For regular cleaning, we suggest using a neutral liquid detergent with a soft sponge or a microfiber cloth. It is advisable to clean the kitchen frequently instead of doing it more thoroughly at longer intervals. In spite of the endurance of the surfaces, dirt tends to build up over time. In order to void the use of abrasive cleaning products, clean it regularly at short intervals.

Persistent stains - Persistent stains can be removed with a slightly abrasive sponge; if necessary, use a specially formulated stain remover. Do not use steel wool pads, because these would leave metal traces that would then have to clean again.

To eliminate dust, grease stains, fingerprints and cooking fumes, dissolve some mild soap in a container of warm water. Wipe the cabinets with a damp cloth and then dry all surfaces, specially the corners, with a soft clean dry cloth.

PRECAUTIONS

- Remove any spills of staining liquids (like coffee, tea, red wine), caustic substances (such as oven cleaner), acids and colorants as soon as possible and rinse with water.
- NEOTRA STONE surfaces are particularly resistant to thermal shocks. You can place hot pans directly on the surface, however we recommend the use of trivets to protect the surface over time.
- Ceramic knives can damage the surface, therefore, we recommend to use cutting boards.
- Avoid hitting the most delicate parts of the surface, such as its corners and edges.
- Cleaning products that give off corrosive vapours may alter the finish of metal fittings and accessories inside a sink base unit or a cleaning product unit
- If you have any doubts about the effect a cleaning product might have on a surface, we recommend trying it in a less visible place to check for any changes in colour or other alterations.

Caution

Observe The Detergent Manufacturers Precautions And Recommended Dilutions, Do Not Use Products Containing Hydrofluoric Acid Or Its Derivatives

NEOTRA STONE CLEANING INSTRUCTIONS

DAY TO DAY CLEANING

Neotra stones are very easy to clean and does not require special maintenance. For daily care, use neutral detergents diluted with plenty of hot water. Detergents should not contain wax or leave glossy stains. Dry with a good quality microfiber cloth. Rinse with water once cleaned and clean off the water using another dry microfiber cloth. The detergents used should be diluted on the basis of information provided on the product packaging. Carry out a first cleaning upon the installation of the kitchen stone in order to remove traces or residues of mastics and silicones possibly used during installation. With time and with the use of ordinary detergents sold commercially, opaque films can be formed on the surface of the plate. Some drink such as Coca Cola @,water and wine, if spilt on the surface of the tile could eliminate these films and restore the original appearance. The "stains" created by drinks will be the only really clean parts of the tile. To avoid the formation of these waxes, and opaque stains, it is recommended to use only neutral detergents for routine cleaning. To remove the above mentioned stains the entire surface of the tile must be "dewaxed".

Neutral, wax-free detergent list	
() Follow the instructions given on the package. Test the product before actual use. This applies in particular to honed or polished products.	
Name of detergent	Manufacturer
Floor Cleaner	Faberchimica
Fila Cleaner	Fila
Pflegereiniger	Lithofin
HMK P15	HMK
Bonamain Plus	Bonasytems Italia
Bonadecon	Bonasytems Italia

! Neutral, wax-free detergent list		
Support to clean	What do you see?	What should you do?
NEOTRA STONE	Glossy stains 	What should you do? Apply a slightly acidic detergent (such as Tile Cleaner by FABERCHIMICA or Bonamain PLUS the Bonasy stems Italy) undiluted and leave for 5-10 minutes. Rub with a white pad, rinse well with water and dry with microfiber cleaning cloth.
	It stains, absorbs 	

CLEANING & MAINTENANCE

Our products are non porous (due to their high quality raw materials, stringent production parameters and state of the art technology), hence any dust or deposited waste cannot penetrate the surface.

For most cases only a damp cloth is sufficient for cleaning.

Regular cleaning highlights the aesthetic features of the surface and gives it exceptional shine.

For highly aggressive cleaning caused by some common food and substances follow the table below.

TYPES OF STAIN	CLEANING SOLUTIONS
Grease	Detergent, Red Harpic, Blue Harpic, Vim-bar.
Oil	Backing Soda, Vim-bar, Detergent, Ala+blue Harpic.
Ink	Alcohol, Liquid Bleach, Nail Paint Remover, Thinner, Detergent, Cleanza Tc.
Rust	Mild Hydrochloric Acid, vinegar, Liquid Bleach, Nail Paint Remover, Thinner, Detergent, Cleanza Tc.
Lime	Descaling Reagent, Mild Hydrochloric Acid, liquid Bleach, Detergent, Cleanza Tc, Ala+blue Harpic.
Cement	Mild Hydrochloric Acid, Cleanza Tc, Ala+blue Harpic.
Wine	Liquid Bleach, Detergent, Ala+blue Harpic, Cleanza Tc.
Coffee	Liquid Bleach, Detergent, Ala+blue Harpic, Cleanza Tc.
Rubber	Alcohol, Thinner, Liquid Bleach, Detergent, Ala+blue Harpic.
Plaster	Mild Hydrochloric Acid, Detergent, Ala+blue Harpic, Cleanza Tc
Candle Wax	Alcohol, Thinner, Detergent, Ala+blue Harpic, Cleanza Tc.
Iodine	Liquid Bleach, Detergent, Ala+blue Harpic, Cleanza Tc, Mild Hydrochloric Acid.
Blood	Liquid Bleach, Detergent, Ala+blue Harpic, Cleanza Tc, Mild Hydrochloric Acid.
Ice Cream	Liquid Bleach, Detergent, Vim-bar, Ala+blue Harpic.

NEOTRA STONE



QUARTZ'S STONE

1) Neotra stone is a material that features several great benefits. It comes in an array of timeless designs, including desirable white veined (satuario) and dark marble looks, so you can find what fits your style, it looks like natural stone slabs

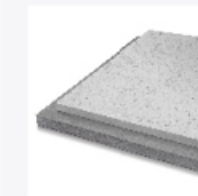

1) Quartz comes in various color, but it does not resemble to natural stones, apparently it looks like man made designs, and cannot match with natural stones.

2) The biggest difference between quartz countertops and porcelain countertops is in terms of their heat resistance. Porcelain is highly resistant to heat and is totally unimpacted, as it is fired at 1200° centigrade.



2) The countertops cannot take much heat beyond a point. Their surface cracks when high heat utensils (above 150 to 200 degrees centigrade) are placed on them.

3) Color of Neotra stone remain same even in outdoor kitchen and not effected by UV. It will never fade even if used outdoor

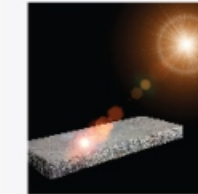

3) Quartz slabs loses its color and shine if exposed to direct sun light, due to ultraviolet ray.

4) Stain resistance from Tea, coffee, juices turmeric and various household chemicals. It can be cleaned even if the stains are dry.



4) Quartz slabs are highly vulnerable to Tea, Coffee, wine, turmeric if not cleaned immediately then chances of stains are very high

5) Porcelain is Stronger than Granite & Quartz's slab, while many people think granite is a durable countertop material, it's not. Porcelain is 30% stronger than granite. The firing process of porcelain helps make your countertop material very permanent, so you won't need to worry about chips, scratches, cracks, and essential wear and tear.



5) Quartz's slabs are not as stronger as Porcelain

NEOTRA STONE



QUARTZ'S STONE

6) If you do use chemicals like bleach when you clean your countertop, you won't have to worry. Harsher chemicals for cleaning won't do any damage to your porcelain countertop. Compared to natural stone, that will save you a lot of time with maintenance



6) Since quartz slabs are resin based and cannot tolerate harsher chemical, the cleaning chemical should have PH value of minimum "6" and above (lesser the PH value harsher the chemical properties)

7) while buying Neotra you get value for money, it is cheaper than quartz



7) Normally Quartz's slabs are abnormally expensive.

8) Neotra stone will have no weather, for any number of years, will remain intact with cement or construction chemical.



8) Quartz's slabs are highly prone to weather conditions, due to extreme summer or winter the process of expansion and contraction will effect the Quartz's slab as a result it may bent, or leave the ground surface.

9) Neotra stone can be used for any kind of flooring or surfaces.



9) Quartz's cannot be used for flooring due to all above reasons.
